

JEDNOSTAVNIJE I MUDRIJE NEGO IKAD

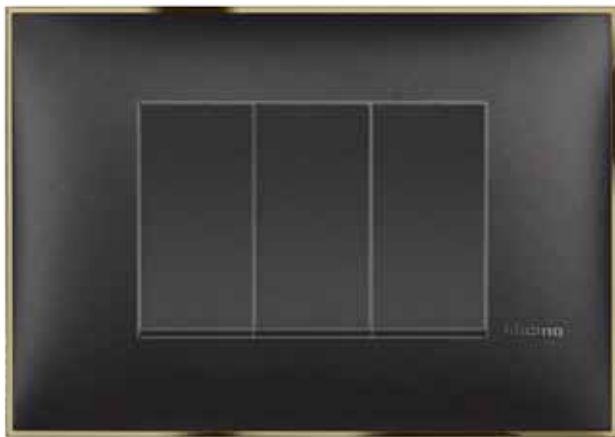

———— Classia ————

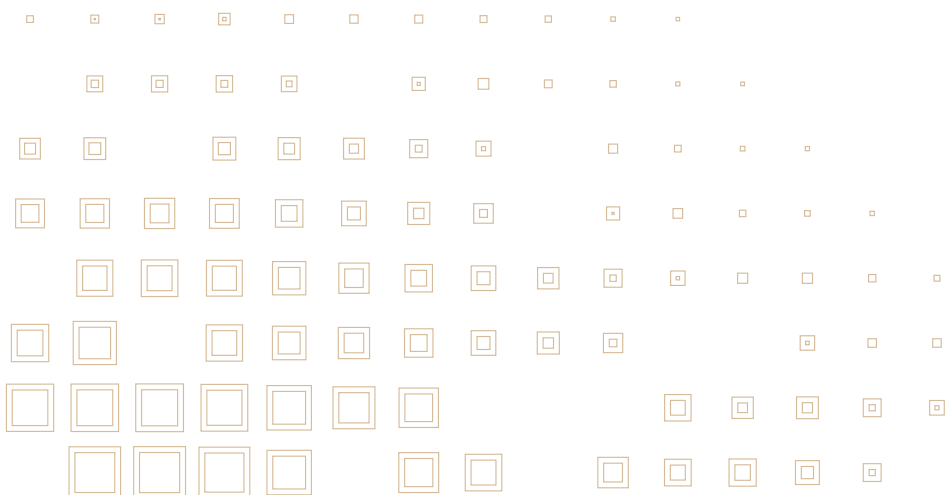



Classia —

- 2 **JEDNOSTAVAN** OBLIK
- 6 **JEDNOSTAVNA** UGRADNJA
- 8 **MUDAR** IZBOR
- 10 **MUDRA** REŠENJA
- 12 KATALOG

JEDNOSTAVAN OBLIK

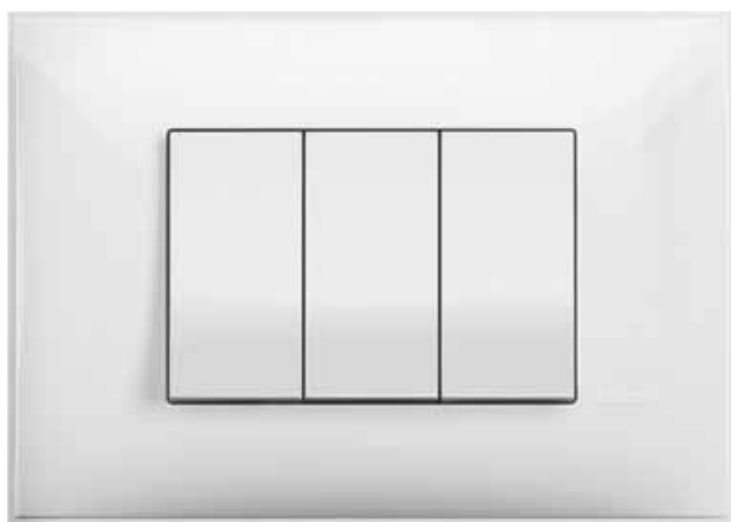

Moderan izgled, oivičen oštrom ivicom koja je u kontrastu sa blago zakrivljenom površinom. Okvir daje jedinstven izgled vašem prekiđaću.





Mehanizmi u dve boje:
sjajno bela i crni saten

Tonirani okvir sa metalnim efektom
zlata, hroma, nikla



Moderan izgled, ovičen oštrom ivicom koja je u kontrastu sa blago zakrivljenom površinom.

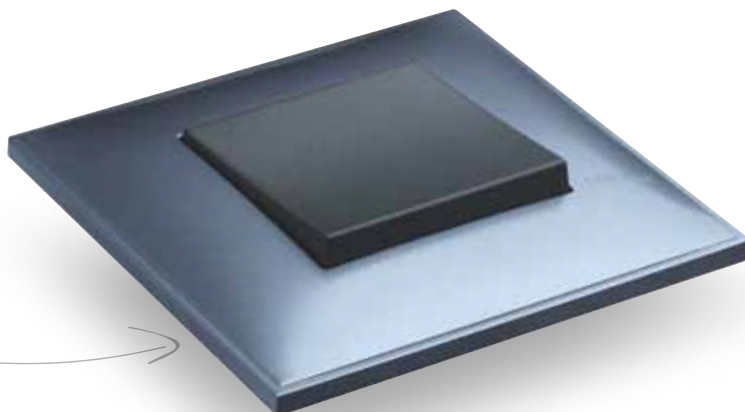

Diskretno zakrivljena površina tastera



PREKIDAČ : 2 RAZLIČITE VERZIJE
 Neosvetljen: uvek istog izgleda
 Osvetljen led sijalicom: jasna i intenzivna svetlosna indikacija



Visoke performanse i kvalitet za savršenu ugradnju u svaki tip dozne i svaki tip zida. Okviri dizajnirani da odgovaraju i evropskim i italijanskim standardima.

JEDNOSTAVNA UGRADNJA



SISTEM UGRADNJE

- Inovativni regulacioni sistem okvira omogućava da okvir uvek bude u ravni sa zidom
- Jednostavna ugradnja i uklanjanje mehanizma

Nosač za fiksiranje zavrtnjima

UGRADNJA U GIPS:

- Uklonjiva ploča garantuje savršeno poravnanje okvira i ugradnih prekidača na gipsani zid.

METALNI DODATAK:

- Čini nosač čvršćim.
- Metalni otvori za bolje fiksiranje zavrtnjima.

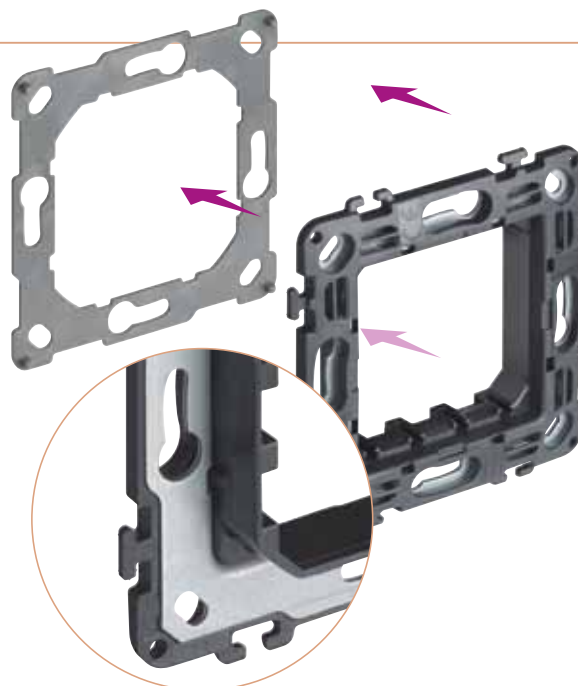

Nosač sa žabicama

Žabice za fiksiranje

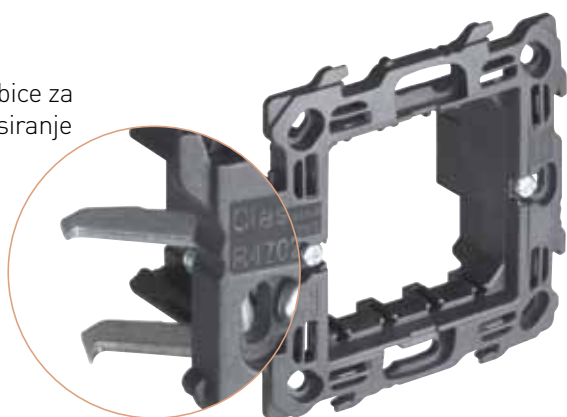

Inovativni sistem vezivanja za ugradnju više mehanizama.

Ukoliko je potrebno moguće je ukloniti žabice i nosač fiksirati zavrtnjima.

Savršeno ravnanje uz pomoć inovativnog sistema za vezivanje nosača. Visoka otpornost zahvaljujući specijalnom materijalu.

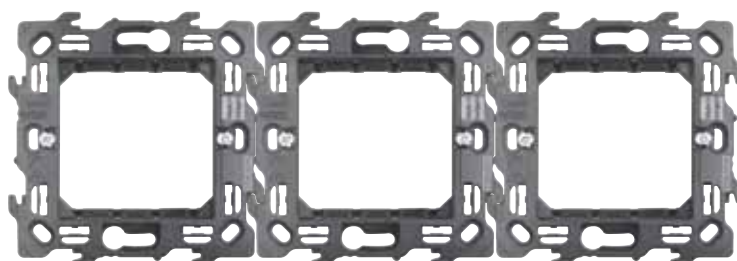

16 boja okvira koji se mogu kombinovati sa 2 boje maske mehanizama: sjajno bela - crni saten. Bogatstvo izbora raste sa toniranim okvirima sa metalnim efektom zlata, hroma, nikla

MUDAR

IZBOR



OSNOVNE



RAMOVI



BOJE



AKCENTI



Jedinstvena i kompletna
ponuda svih modularnih
sistema:
italijanski i evropski standard.

MUDRA

REŠENJA

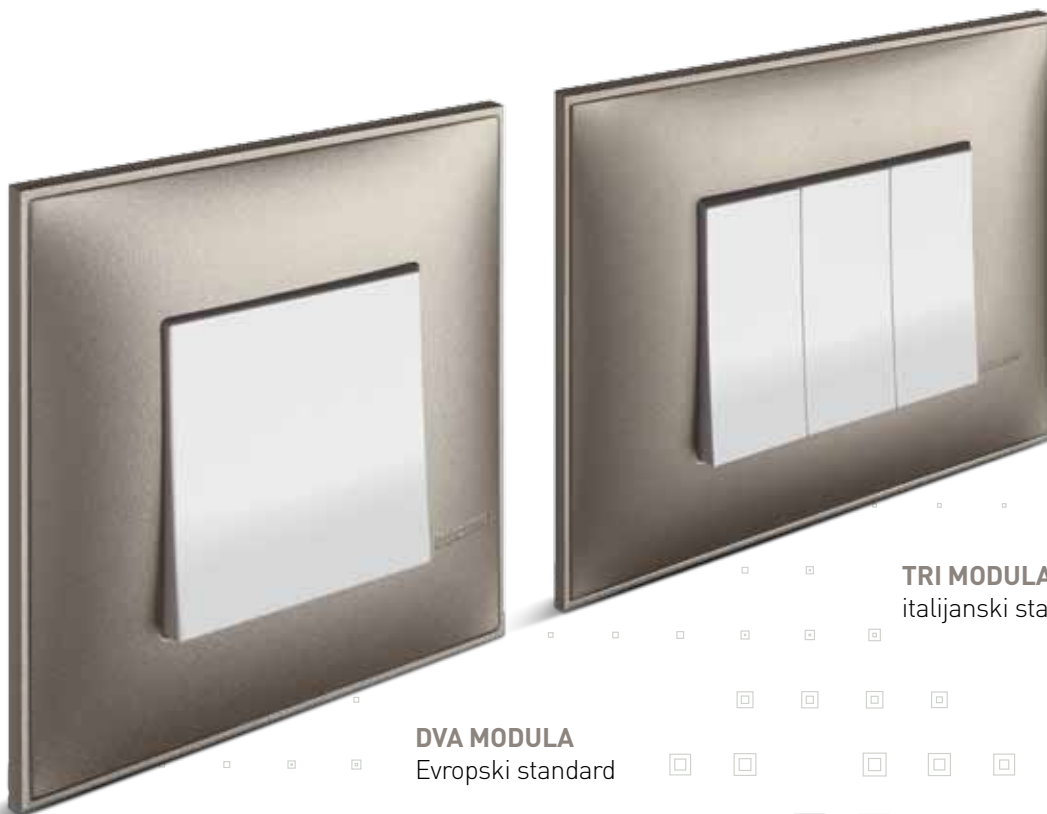

DVA MODULA
Evropski standard

TRI MODULA
italijanski standard

SVE MOGUĆE KOMBINACIJE

6 kombinacija za evropski sistem ugradnje - od jednostrukih do petostrukih okvira

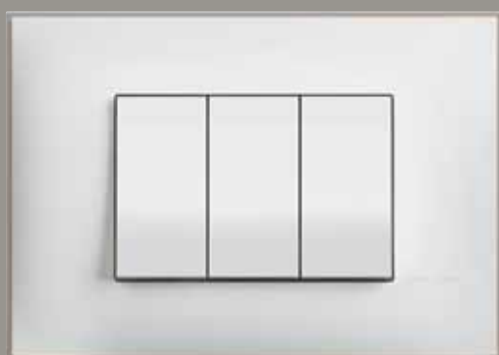
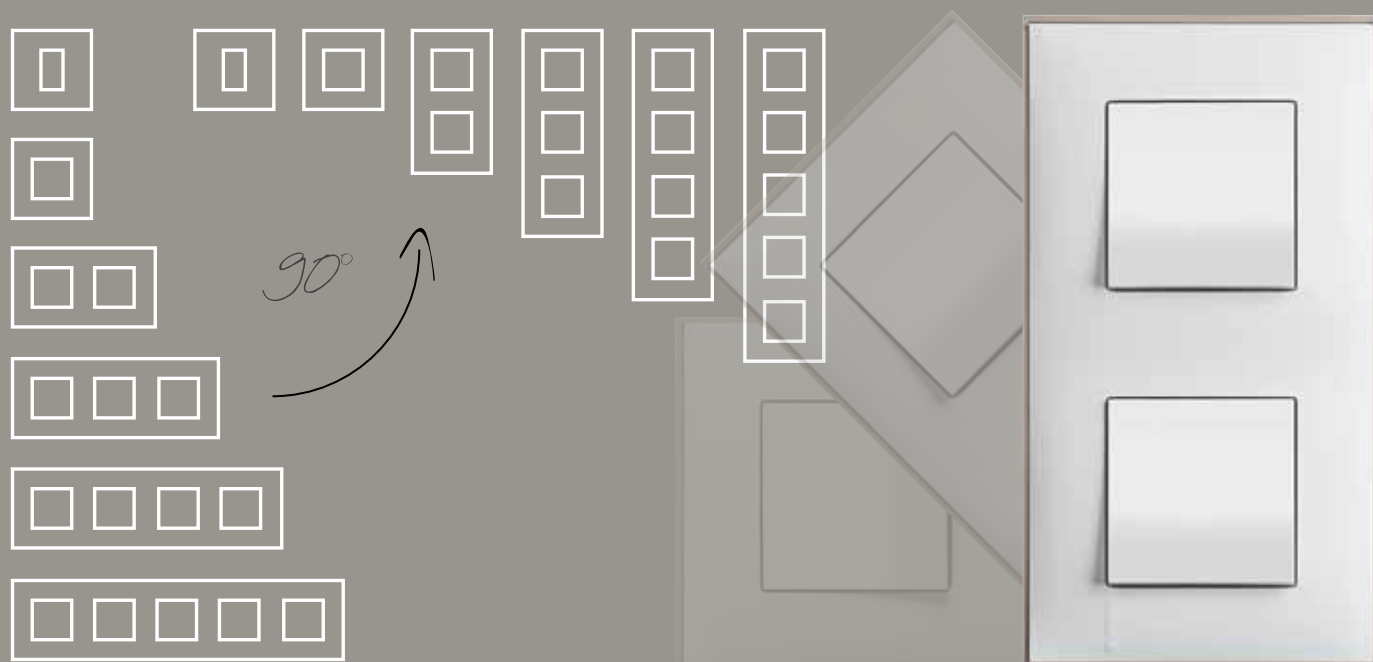

5 kombinacija za italijanski sistem ugradnje - od jednog do sedam modula



CLASSIA

Prekidači

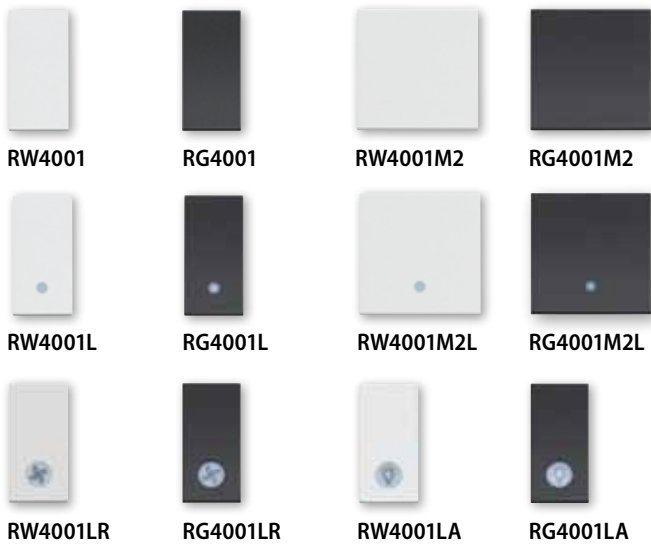

Kataloški broj

PREKIDAČ JEDNOPOLNI - 10 AX - 250 V~

<input type="checkbox"/> RW4001	Veličine 1 modula - bela boja
<input checked="" type="checkbox"/> RG4001	Veličine 1 modula - crna boja
<input type="checkbox"/> RW4001M2	Veličine 2 modula - bela boja
<input checked="" type="checkbox"/> RG4001M2	Veličine 2 modula - crna boja

PREKIDAČ JEDNOPOLNI - 10 AX - 250 V~ - FUNKCIJA OSVETLJENJA, ISPORUČUJE SE SA LED SIJALICOM 230 V

<input type="checkbox"/> RW4001L	Veličine 1 modula - bela boja
<input checked="" type="checkbox"/> RG4001L	Veličine 1 modula - crna boja
<input type="checkbox"/> RW4001M2L	Veličine 2 modula - bela boja
<input checked="" type="checkbox"/> RG4001M2L	Veličine 2 modula - crna boja

PREKIDAČ JEDNOPOLNI - 10 AX - 250 V~ - FUNKCIJA OSVETLJENJA, ISPORUČUJE SE SA LED SIJALICOM 230 V - SA SIMBOLOM

<input type="checkbox"/> RW4001LR	Veličine 1 modula - sa simbolom ventilatora - bela boja
<input checked="" type="checkbox"/> RG4001LR	Veličine 1 modula - sa simbolom ventilatora - crna boja
<input type="checkbox"/> RW4001LA	Veličine 1 modula - sa simbolom sijalice - bela boja
<input checked="" type="checkbox"/> RG4001LA	Veličine 1 modula - sa simbolom sijalice - crna boja

PREKIDAČ NAIZMENIČNI - 10 AX - 250 V~

<input type="checkbox"/> RW4003	Veličine 1 modula - bela boja
<input checked="" type="checkbox"/> RG4003	Veličine 1 modula - crna boja
<input type="checkbox"/> RW4003M2	Veličine 2 modula - bela boja
<input checked="" type="checkbox"/> RG4003M2	Veličine 2 modula - crna boja

PREKIDAČ NAIZMENIČNI - 10 AX - 250 V~ - FUNKCIJA OSVETLJENJA, ISPORUČUJE SE SA LED SIJALICOM 230 V

<input type="checkbox"/> RW4003L	Veličine 1 modula - bela boja
<input checked="" type="checkbox"/> RG4003L	Veličine 1 modula - crna boja
<input type="checkbox"/> RW4003M2L	Veličine 2 modula - bela boja
<input checked="" type="checkbox"/> RG4003M2L	Veličine 2 modula - crna boja

PREKIDAČ UNAKRSNI - 10 AX - 250 V~

<input type="checkbox"/> RW4004	Veličine 1 modula - bela boja
<input checked="" type="checkbox"/> RG4004	Veličine 1 modula - crna boja
<input type="checkbox"/> RW4004M2	Veličine 2 modula - bela boja
<input checked="" type="checkbox"/> RG4004M2	Veličine 2 modula - crna boja

PREKIDAČ UNAKRSNI - 10 AX - 250 V~ - FUNKCIJA OSVETLJENJA, ISPORUČUJE SE SA LED SIJALICOM 230 V

<input type="checkbox"/> RW4004L	Veličine 1 modula - bela boja
<input checked="" type="checkbox"/> RG4004L	Veličine 1 modula - crna boja
<input type="checkbox"/> RW4004M2L	Veličine 2 modula - bela boja
<input checked="" type="checkbox"/> RG4004M2L	Veličine 2 modula - crna boja

PREKIDAČ DVOPOLNI - 16 AX - 250 V~ - FUNKCIJA OSVETLJENJA, ISPORUČUJE SE SA LED SIJALICOM 230 V

<input type="checkbox"/> RW4002L	Veličine 1 modula - bela boja
<input checked="" type="checkbox"/> RG4002L	Veličine 1 modula - crna boja

PREKIDAČ JEDNOPOLNI - 16 AX - 250 V~ - FUNKCIJA OSVETLJENJA, ISPORUČUJE SE SA LED SIJALICOM 230 V - SA SIMBOLOM

<input type="checkbox"/> RW4001LS	Veličine 1 modula - sa simbolom bojlera - bela boja
<input checked="" type="checkbox"/> RG4001LS	Veličine 1 modula - sa simbolom bojlera - crna boja
<input type="checkbox"/> RW4001LP	Veličine 1 modula - sa simbolom grejalice - bela boja
<input checked="" type="checkbox"/> RG4001LP	Veličine 1 modula - sa simbolom grejalice - crna boja

CLASSIA

Prekidači



Kataloški broj

TASTERI

<input type="checkbox"/> RW4005	1P (NO) 10 A - 250 Va.c. - 1 modul - bela boja
<input checked="" type="checkbox"/> RG4005	1P (NO) 10 A - 250 Va.c. - 1 modul - crna boja
<input type="checkbox"/> RW4005L	1P (NO) 10 A - 250 Va.c. - funkcija osvetljenja, isporučuje se sa led sijalicom 230 V - 1 modul - bela boja
<input checked="" type="checkbox"/> RG4005L	kao gore navedeno - crna boja
<input type="checkbox"/> RW4042V230	1P (NO) 10 A - 250 Va.c. - sa simbolom zvona - funkcija osvetljenja, isporučuje se sa led sijalicom 230 V - 1 modul - bela boja
<input checked="" type="checkbox"/> RG4042V230	kao gore navedeno - crna boja
<input type="checkbox"/> RW4042V12	1P (NO) 10 A - 250 Va.c. - sa simbolom zvona - funkcija osvetljenja, isporučuje se sa led sijalicom 12/24 V - 1 modul - bela boja
<input checked="" type="checkbox"/> RG4042V12	kao gore navedeno - crna boja
<input type="checkbox"/> RW4043	taster 1P (NO) 10 A - 250 Va.c. - sa simbolom sijalice - funkcija osvetljenja, isporučuje se sa led sijalicom 230 V - bela boja
<input checked="" type="checkbox"/> RG4043	kao gore navedeno - crna boja
<input type="checkbox"/> R4040	taster 1P (NO) 10A sa nosačem natpisa - 2 modula
<input type="checkbox"/> RW4005M2	1P (NO) 10 A - 250 Va.c. - 2 modula - bela boja
<input checked="" type="checkbox"/> RG4005M2	kao gore navedeno - crna boja
<input type="checkbox"/> RW4005M2L	1P (NO) 10 A - 250 Va.c. - funkcija osvetljenja, isporučuje se sa led sijalicom 230 V - 2 modula - bela boja
<input checked="" type="checkbox"/> RG4005M2L	kao gore navedeno - crna boja

OSTALI PREKIDAČI

<input type="checkbox"/> RW4001B3	prekidač za kupatilo sa funkcijom indikacije za tri nezavisna strujna kruga 10/2x16A 250 Va.c. (svetlo, grejalica, bojler)
<input type="checkbox"/> RW4001B4	prekidač za kupatilo sa funkcijom indikacije za četiri nezavisna strujna kruga 2x10/2x16A 250 Va.c. (svetlo, ventilator, grejalica, bojler)

PASIVNI IR PREKIDAČI

<input type="checkbox"/> RW4431	automatski prekidači opremljeni infracrvenim senzorom, za sve tipove osvetljenja uključujući i LED sijalice - 3-žično ožičenje - podešavanje praga reagovanja jačine svetla - mogućnost podešavanja odloženog isključenja od 30 sek do 10 minuta - napajanje 230 Va.c. - veličine 1 modula - bela boja
<input checked="" type="checkbox"/> RG4431	kao gore navedeno - crna boja

KONTROLA ROLETNI

<input type="checkbox"/> RW4037	1P(NO) + 1P(NO) 10A - 250 Va.c, dvostruki taster sa međublokadom, veličine 1 modula - bela boja
<input checked="" type="checkbox"/> RG4037	kao gore navedeno - crna boja
<input type="checkbox"/> RW4027	izborni prekidač 1P 10A - 250Va.c - veličine 1 modula - bela boja
<input checked="" type="checkbox"/> RG4027	kao gore navedeno - crna boja

CLASSIA

Dimeri



RW4402



RG4402



040149



RW4411







RG4411

DIMER

<input type="checkbox"/> RW4402	Kružni dimer 40 - 400 W 230 Va.c. - 2 modula - bela boja
<input checked="" type="checkbox"/> RG4402	kao gore navedeno - crna boja
<input type="checkbox"/> RW4411	univerzalni dimer (za otporničke - induktivne, kapacitivne potrošače, fluokompakt i LED sijalice) 75/200 W sa elektronskom zaštitom - 2 modula - bela boja
<input checked="" type="checkbox"/> RG4411	kao gore navedeno - crna boja
<input type="checkbox"/> 040149	Kompenzator

Potrošači

Kat.br.	Tip potrošača	Snaga (Va.c.)	Napajanje					
				Inkandescentne i halogene sijalice	Halogene sijalice sa feromagnetskim transformatorom	Halogene sijalice sa elektronskim transformatorom	Dimabilne fluokompakt sijalice	Dimabilne LED sijalice
RW4402 RG4402	Otpornički	230 50	230 Va.c.	40 ÷ 400 W				
RW4411 RG4411	Univerzalni	100 ÷ 240 50 ÷ 60	230 Va.c. 100 Va.c.	3 ÷ 200 W 3 ÷ 400 W	3 ÷ 200 VA 3 ÷ 400 VA	3 ÷ 200 VA 3 ÷ 400 VA	3 ÷ 75 W 3 ÷ 150 W	3 ÷ 75 W 3 ÷ 150 W

Energetske utičnice



RW4141



RG4141



R4141A



R4141R



R4141V



RW4141C



RG4141C

Kataloški broj

NEMAČKI STANDARD

<input type="checkbox"/> RW4141	Energetska utičnica 2P+E 16A 250 Va.c. - sa bočnim kontaktima za uzemljenje, zaštita od slučajnog dodira - bela boja
<input checked="" type="checkbox"/> RG4141	kao gore navedeno - crna boja
<input type="checkbox"/> R4141A	kao gore navedeno - narandžasta boja
<input type="checkbox"/> R4141R	kao gore navedeno - crvena boja
<input type="checkbox"/> R4141V	kao gore navedeno - zelena boja
<input type="checkbox"/> RW4141C	Energetska utičnica 2P+E 16A 250 Va.c. - sa bočnim kontaktima za uzemljenje, zaštita od slučajnog dodira, sa IP20 poklopcem - bela boja
<input checked="" type="checkbox"/> RG4141C	kao gore navedeno - crna boja

CLASSIA

Energetske utičnice



RW4180 RG4180 R4180R

RW4140A16 RG4140A16 R4140A16R

ITALIJANSKI STANDARD

<input type="checkbox"/> RW4180	Energetska utičnica 2P+E 16A 250 Va.c. - 19 mm i 26 mm osno rastojanje - zaštita od slučajnog dodira - za utikače 2P i 2P + E 10 i 16A italijanski standard - bela boja
■ RG4180	kao gore navedeno - crna boja
○ R4180R	kao gore navedeno - crvena boja
<input type="checkbox"/> RW4140A16	Energetska utičnica 2P+E 10/16A 250 Va.c. - 19 mm i 26 mm osno rastojanje - sa bočnim kontaktima i centralnim kontaktom za uzemljenje, odgovara standardnim italijanskim utikačima 2P i 2P+E 10/16A kao i nemačkim standardnim utikačima 2P+E 16A - bele boje
■ RG4140A16	kao gore navedeno - crna boja
○ R4140A16R	kao gore navedeno - crvena boja



RW4125 RG4125

EURO AMERIČKI STANDARD

<input type="checkbox"/> RW4125	Energetska utičnica 2P 16A 127/250 Va.c. - zaštita od slučajnog dodira - bela boje
■ RG4125	kao gore navedeno - crna boja



RW4287C2 RG4287C2

RW4286C2 RG4286C2

UTIČNICE USB PUNJAČI

<input type="checkbox"/> RW4287C2	USB punjač TIP A i C za brzo punjenje jednog uređaja (mobilnog telefona, smart uređaja, tableta ili slično) izlaznog napona 5Vdc - struja 3000 mA za jedan uređaj ili dva uređaja istovremeno po 1500mA - ulazno napajanje 110÷230 Va.c, struja 50÷60 Hz - veličine 2 modula - bela boja
■ RG4287C2	kao gore navedeno - crna boja
<input type="checkbox"/> RW4286C2	USB punjač tip C za brzo punjenje jednog uređaja (mobilnog telefona, smart uređaja, tableta ili slično) izlaznog napona 5Vdc - struja 3000 mA za jedan uređaj ili dva uređaja istovremeno po 1500mA - ulazno napajanje 110÷230 Va.c, struja 50÷60 Hz - veličine 2 modula - bela boja
■ RG4286C2	kao gore navedeno - crna boja

CLASSIA

TV utičnice



TV UTIČNICE

<input type="checkbox"/> RW4202D	TV utičnica - zvezda; Ad direktno slabljenje <1dB; Opseg (FM-VHF-UHF-SAT) 40MHz do 2050MHz; ø9.5mm; muški konektor - veličine 1 modula - bela boja
<input checked="" type="checkbox"/> RG4202D	kao gore navedeno - crna boja
<input type="checkbox"/> RW4202P10	TV utičnica - završna - sa ugrađenim 75Ω otpornikom (završna); Ap prolazno slabljenje (FM-VHF-UHF-SAT) 40MHz do 2250MHz<1,5dB; Ad direktno slabljenje (FM-VHF-UHF) 40MHz do 2250MHz<110dB; ø9.5mm; muški konektor - veličine 1 modula - bela boja
<input checked="" type="checkbox"/> RG4202P10	kao gore navedeno - crna boja
<input type="checkbox"/> RW4202P14	TV utičnica - prolazna; Ap prolazno slabljenje <1,5dB; Ad direktno slabljenje do 862MHz<14dB; Ad direktno slabljenje (SAT) 2250MHz<15,5dB; ø9.5mm; muški konektor - veličine 1 modula - bela boja
<input checked="" type="checkbox"/> RG4202P14	kao gore navedeno - crna boja
<input type="checkbox"/> RW4217M2D	TV+SAT (F konektor) utičnica - zvezda - veličine 2 modula - bele boje
<input checked="" type="checkbox"/> RG4217M2D	kao gore navedeno - crna boja
<input type="checkbox"/> RW4217M2P10	TV+SAT (F konektor) utičnica - završna - veličine 2 modula - bele boje
<input checked="" type="checkbox"/> RG4217M2P10	kao gore navedeno - crna boja
<input type="checkbox"/> RW4217M2P14	TV+SAT (F konektor) utičnica - prolazna - veličine 2 modula - bele boje
<input checked="" type="checkbox"/> RG4217M2P14	kao gore navedeno - crna boja
<input type="checkbox"/> RW4210M2D	Oklopljena TV+RD+SAT utičnica, u izlivenom kućištu - veličine 2 modula - bela boja
<input checked="" type="checkbox"/> RG4210M2D	kao gore navedeno - crna boja
<input type="checkbox"/> RW4202F	TV utičnica sa konektorom tipa F - impedanse 75Ω, sa navrtnjem - veličine 2 modula - bela boja
<input checked="" type="checkbox"/> RG4202F	kao gore navedeno - crna boja

CLASSIA

Telefonske i računarske utičnice



Kataloški broj	RJ UTIČNICE
<input type="checkbox"/> RW4258RJ11	R11 utičnica tip povezivanja K10 - veličine 1 modula - bela boja
<input checked="" type="checkbox"/> RG4258RJ11	kao gore navedeno - crna boja
<input type="checkbox"/> RW4279C5E	RJ45 utičnica kategorija 5E UTP - povezivanje bez dodatnog alata - veličine 1 modula - bela boja
<input checked="" type="checkbox"/> RG4279C5E	kao gore navedeno - crna boja
<input type="checkbox"/> RW4279C6	RJ45 utičnica kategorija 6 UTP - povezivanje bez dodatnog alata - veličine 1 modula - bela boja
<input checked="" type="checkbox"/> RG4279C6	kao gore navedeno - crna boja
<input type="checkbox"/> RW4279C6S	RJ45 utičnica kategorija 6 STP - povezivanje bez dodatnog alata - veličine 1 modula - bela boja
<input checked="" type="checkbox"/> RG4279C6S	kao gore navedeno - crna boja
<input type="checkbox"/> RW4279C6AS	RJ45 utičnica kategorija 6A STP - povezivanje bez dodatnog alata - veličine 1 modula - bela boja
<input checked="" type="checkbox"/> RG4279C6AS	kao gore navedeno - crna boja

Mehanizmi za zvučnu i svetlosnu signalizaciju



Kataloški broj	ZVONA I ZUJALICE
<input type="checkbox"/> RW4351V230	zvono 230 Va.c. 8VA - veličine 1 modula - bela boja
<input checked="" type="checkbox"/> RG4351V230	kao gore navedeno - crna boja
<input type="checkbox"/> RW4356V230	zujalica 230 Va.c. 8VA - veličine 1 modula - bela boja
<input checked="" type="checkbox"/> RG4356V230	kao gore navedeno - crna boja



Kataloški broj	PRENOSIVA PROTIVPANIČNA SVETILJKA
<input type="checkbox"/> R4380	Izvlačiva protivpanična svetiljka automatski se uključuje po nestanku struje - opremljena sa LED sijalicom bele boje - ON/OFF prekidač i SPOT taster za povećanje nivoa osvetljenja po potrebi - zamenljive Ni-Mh baterije sa autonomijom 2h - potrošnja u mirnom režimu 0,4W - napajanje 127/230V. Postolje za punjenje svetiljke, veličine 2 modula.
<input type="checkbox"/> 4380NB	Rezervna baterija za prenosivu protivpaničnu svetiljku kat.br. R4380

Slepe maske



Kataloški broj	SLEPE MASKE
<input type="checkbox"/> RW4950	Slepa maska - veličine 1 modula - bela boja
<input checked="" type="checkbox"/> RG4950	kao gore navedeno - crna boja
<input type="checkbox"/> RW4953	uvod kabla sa otvorom $\varnothing 9.5$ mm - veličine 1 modula - bela boja
<input checked="" type="checkbox"/> RG4953	kao gore navedeno - crna boja

CLASSIA

Hotelska ponuda



RW4033



RG4033



RW4028H



RG4028H



RW4373H



RG4373H



RW4139



RG4139



RW4177



RG4177



RW4549



RG4549



RW4441



RG4441

Kataloški broj

POTEZNI TASTER

<input type="checkbox"/> RW4033	1P (NO) 10 A - 250 Va.c. potezni taster - veličine 1 modula - bela boja
<input checked="" type="checkbox"/> RG4033	kao gore navedeno - crna boja

ČIŠĆENJE SOBE / NE UZNE MIRAVAJ

<input type="checkbox"/> RW4028H	1P 10 A - 250Va.c. dvostruki izborni prekidač 1-0-2 sa međublokadom i dvostrukom oznakom: „čišćenje sobe“ i „ne uznemiravaj“ - veličine 1 modula - bela boja
<input checked="" type="checkbox"/> RG4028H	kao gore navedeno - crna boja
<input type="checkbox"/> RW4373H	mehanizam za funkciju vizuelne signalizacije: „čišćenje sobe“ i „ne uznemiravaj“ - veličine 1 modula - bela boja
<input checked="" type="checkbox"/> RG4373H	kao gore navedeno - crna boja

MULTISTANDARD ENERGETSKA UTIČNICA

<input type="checkbox"/> RW4139	energetska utičnica 2P+E 5/6/10/13 A 250 Va.c. i 127 Va.c. multistandard - 5A i 13A = britanski; 6A = indijski; 10A = evropski standard - bela boja
<input checked="" type="checkbox"/> RG4139	kao gore navedeno - crna boja

UTIČNICA ZA BRIJANJE

<input type="checkbox"/> RW4177	utičnica za brijanje 230V - bela boja
<input checked="" type="checkbox"/> RG4177	kao gore navedeno - crna boja

KARTIČNI DRŽAČ

<input type="checkbox"/> RW4549	kartični držač za uključenje svetla i uređaja u hotelskoj sobi - slot za karticu osvetljen integrisanom sijalicom - odloženo isključenje - maks.opterećenje 30 VA 230 Va.c. - veličine 2 modula - bela boja
<input checked="" type="checkbox"/> RG4549	kao gore navedeno - crna boja

SOBNI TERMOSTAT













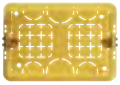

















<input type="checkbox"/> RW4441	elektronski sobni termostat - izlazni NO/NC kontakti 2A, 250 Va.c. - napajanje 230 Va.c. - 50 i 60 Hz - veličine 2 modula - bela boja
<input checked="" type="checkbox"/> RG4441	kao gore navedeno - crna boja

BOJE OKVIRA

OSNOVNE				
	Bela - RW	Krem - CR	Moka - MK	Crna - BC
RAMOVI				
	Led saten - ES	Krem saten - CS	Beli saten - WS	Crni saten - BG
BOJE				
	Titanijum metal - TM	Siena soft - SF	Plavi metal - LM	Meka zemlja - TF
AKCENTI				
	Zlato/bela - WD	Hrom/bela - WR	Nikl/crna - BH	Zlato/crna - BD

















Italijanski sistem ugradnje ("modularno")

TABELA IZBORA

	Ugradnja sa zavrtnjima (malter i gips)	Ugradnja sa žabicama (malter)	Ugradnja sa zavrtnjima (malter i gips)							
Dozne za malter	 080108		 503E	 504E	 506L	 503E				
Dozne za gips	 080041		 PB503N	 PB504N	 PB506N	 PB503N				
Nosači mehanizama	 R4702	 R4702G	 R4703	 R4704	 R4707	 R4703				
Broj modula	 2		 3		 4		 7		 1 centralno	 2 centralno
Okviri	 R4802...		 R4803..		 R4804..		 R4807..		 R4803M1..	 R4819..

Nosači mehanizama mogu da se ugrade na sve dozne italijanskog standarda na tržištu.

OKVIRI

	2	3	4	7	1 centralno	2 centralno
OSNOVNE						
 Bela	R4802RW	R4803RW	R4804RW	R4807RW	R4803M1RW*	R4819RW
 Krem	R4802CR	R4803CR	R4804CR	R4807CR	R4803M1CR*	R4819CR
 Moka	R4802MK	R4803MK	R4804MK	R4807MK	R4803M1MK*	R4819MK
 Crna	R4802BC	R4803BC	R4804BC	R4807BC	R4803M1BC*	R4819BC
RAMOVI						
 Led saten	R4802ES	R4803ES	R4804ES	R4807ES	R4803M1ES*	R4819ES
 Krem saten	R4802CS	R4803CS	R4804CS	R4807CS	R4803M1CS*	R4819CS
 Beli saten	R4802WS	R4803WS	R4804WS	R4807WS	R4803M1WS*	R4819WS
 Crni saten	R4802BG	R4803BG	R4804BG	R4807BG	R4803M1BG*	R4819BG
BOJE						
 Titanijum metal	R4802TM	R4803TM	R4804TM	R4807TM	R4803M1TM*	R4819TM
 Siena soft	R4802SF	R4803SF	R4804SF	R4807SF	R4803M1SF*	R4819SF
 Plavi metal	R4802LM	R4803LM	R4804LM	R4807LM	R4803M1LM*	R4819LM
 Meka zemlja	R4802TF	R4803TF	R4804TF	R4807TF	R4803M1TF*	R4819TF
AKCENTI						
 Zlato/bela	R4802WD	R4803WD	R4804WD	R4807WD	R4803M1WD*	R4819WD
 Hrom/bela	R4802WR	R4803WR	R4804WR	R4807WR	R4803M1WR*	R4819WR
 Nikl/crna	R4802BH	R4803BH	R4804BH	R4807BH	R4803M1BH*	R4819BH
 Zlato/crna	R4802BD	R4803BD	R4804BD	R4807BD	R4803M1BD*	R4819BD

Evropski sistem ugradnje (osno rastojanje 71 mm)

TABELA IZBORA

Ugradnja sa zavrtnjima (malter i gips)	080141	2 x 080141	3 x 080141	4 x 080141	5 x 080141	
	080041	080042	080043	080044	080045	
	R4702	2 x R4702	3 x R4702	4 x R4702	5 x R4702	
Ugradnja sa žabicama (malter)	R4702G	2 x R4702G	3 x R4702G	4 x R4702G	5 x R4702G	
	R4702G	2 x R4702G	3 x R4702G	4 x R4702G	5 x R4702G	
Broj modula	1 centralno	2 modula	2+2 modula	2+2+2 modula	2+2+2+2 modula	
Okviri	R4801...	R4802...	R4802M2..	R4802M3..	R4802M4..	R4802M5..

OKVIRI

	1 centralno	2	2+2 "horiz./vertik. ugradnja"	2+2+2 "horiz./vertik. ugradnja"	2+2+2+2 "horiz./vertik. ugradnja"	2+2+2+2+2 "horiz./vertik. ugradnja"
OSNOVNE						
Bela	R4801RW	R4802RW	R4802M2RW	R4802M3RW	R4802M4RW	R4802M5RW
Krem	R4801CR	R4802CR	R4802M2CR	R4802M3CR	R4802M4CR	R4802M5CR
Moka	R4801MK	R4802MK	R4802M2MK	R4802M3MK	R4802M4MK	R4802M5MK
Crna	R4801BC	R4802BC	R4802M2BC	R4802M3BC	R4802M4BC	R4802M5BC
RAMOVI						
Led saten	R4801ES	R4802ES	R4802M2ES	R4802M3ES	R4802M4ES	R4802M5ES
Krem saten	R4801CS	R4802CS	R4802M2CS	R4802M3CS	R4802M4CS	R4802M5CS
Beli saten	R4801WS	R4802WS	R4802M2WS	R4802M3WS	R4802M4WS	R4802M5WS
Crni saten	R4801BG	R4802BG	R4802M2BG	R4802M3BG	R4802M4BG	R4802M5BG
BOJE						
Titanijum metal	R4801TM	R4802TM	R4802M2TM	R4802M3TM	R4802M4TM	R4802M5TM
Siena soft	R4801SF	R4802SF	R4802M2SF	R4802M3SF	R4802M4SF	R4802M5SF
Plavi metal	R4801LM	R4802LM	R4802M2LM	R4802M3LM	R4802M4LM	R4802M5LM
Meka zemlja	R4801TF	R4802TF	R4802M2TF	R4802M3TF	R4802M4TF	R4802M5TF
AKCENTI						
Zlato/bela	R4801WD	R4802WD	R4802M2WD	R4802M3WD	R4802M4WD	R4802M5WD
Hrom/bela	R4801WR	R4802WR	R4802M2WR	R4802M3WR	R4802M4WR	R4802M5WR
Nikl/crna	R4801BH	R4802BH	R4802M2BH	R4802M3BH	R4802M4BH	R4802M5BH
Zlato/crna	R4801BD	R4802BD	R4802M2BD	R4802M3BD	R4802M4BD	R4802M5BD

CLASSIA

IP55 zaštitni okviri

OPIS

Montaža na doznu
za 2 modula kat.br.
031301 ili 080108



27602

OPIS

Montaža na doznu
za 3 modula
kat.br. 503E



27603

OPIS

Montaža na doznu
za 4 modula
kat.br. 504E



27604

Montaža u nadgradne kutije sa IP40 zaštitom

OPIS

1 modula



27401

OPIS

2 modula



27402

OPIS

3 modula



27403

4 modula



27404

Montaža u nadgradne kutije sa IP55 zaštitom

OPIS

1 modula



27501

OPIS

2 modula



27502

OPIS

3 modula



27503

4 modula



27504

CLASSIA

Podaci o dimenzijama

OKVIRI

Evropski sistem ugradnje

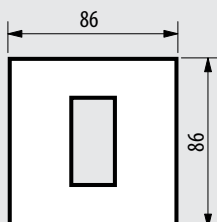

R4801..

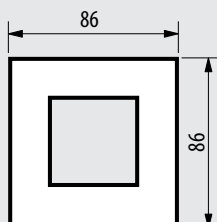

R4802..

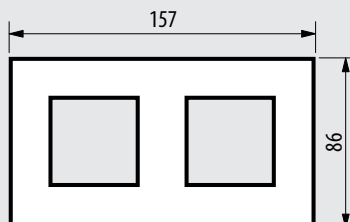

R4802M2..

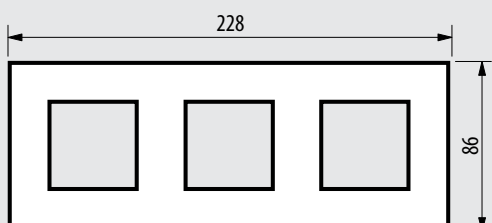

R4801M3..

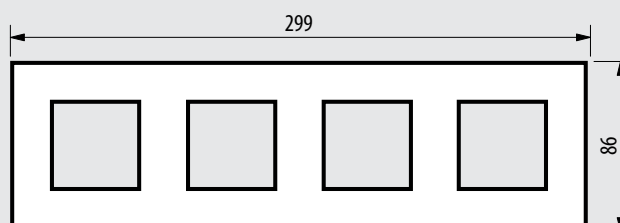

R4801M4..

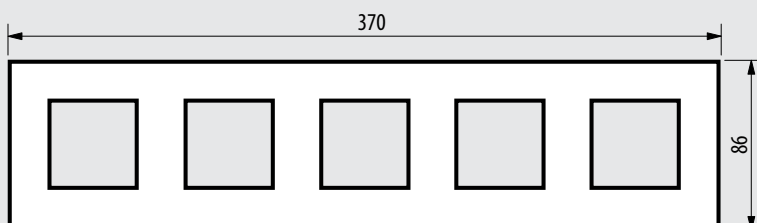

R4801M5..

Italijanski sistem ugradnje

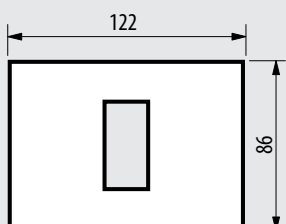

R4803M1..

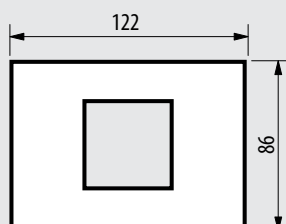

R4819..

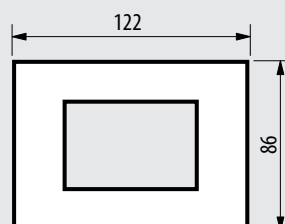

R4803..

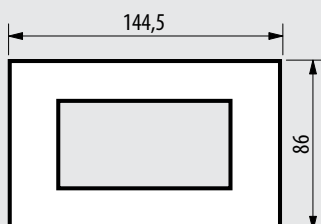

R4804..

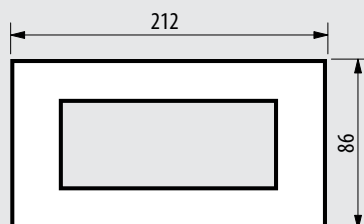

R4807..

CLASSIA

Pakovanje

Pakovanje je dizajnirano za maloprodaje.
Svaki proizvod je zasebno upakovan.



- Sa euroslot otvorom na vrhu
- Informacije o bezbednosti na 11 jezika
- Ean kod
- Informacije o reciklaži ambalaže
- QR kod za tehničke informacije

Discover more



bticino.com

Legrand Electric d.o.o.

Bulevar Zorana Đinđića 144b

11070 Beograd

Tel: +381 11 383 50 60

+381 11 383 52 00

www.legrand.rs



Vaš distributer

bticino

A Group Brand |  **legrand**